

User Manual

Milli-Q® EQ 7008/7016

Ultrapure Water Systems



Table of contents

INTRODUCTION	1
System identification	1
Intended use	1
Installation component	2
Water process	5
QUICK START	8
Exit screensaver	8
Dispense pure water	8
Water quality values	9
Dispense archiving	9
View & manage Alerts and Alarms	10
Navigate the screen interface	11
Collect RO water from the tank front valve	13
CONSUMABLE MENU	14
Consumables identification with card reading	15
INFORMATION MENU	16
System	16
History	16
Flow schematic	17
SETTINGS MENU	18
Manager access (& password)	19
System configuration	20
HMI configuration	21
Accessories	22
Alarm configuration	23
Connectivity	24
Date Time & Language	24
Units	25
MAINTENANCE MENU	26
Consumable installation wizards	26
Cleaning & Sanitization	29
UV lampe	30
Depressurization	30
SELF HELP GUIDE	32
Troubleshooting tips	32
Icons	35
REQUIREMENTS AND SPECIFICATIONS	36
Water specifications	36
System specifications	37
Power and water consumption	39
Dimensions and weights	40
Ordering information	42
LEGAL INFORMATION & WARRANTY	44

INTRODUCTION

Congratulations!

Thank you for buying a Milli-Q® water purification system.

The Milli-Q® EQ 7008/7016 water purification system produces ultrapure and pure water from a tap water source. Installation of this product should be performed by a qualified service representative with access to installation documentation.

This user manual is a guide to be followed during the normal operation and maintenance of a Milli-Q® EQ 7008/7016 water purification system. It is highly recommended to fully read this manual and comprehend its contents before using the water purification system.

System identification

System	Catalogue number	Production flow rate	Voltage	Frequency
Milli-Q® EQ 7008 water system (includes HMI)	ZEQ7008T0C	8 L/h	100-240 V	50/60 Hz
Milli-Q® EQ 7016 water system (includes HMI)	ZEQ7016T0C	16 L/h	100-240 V	50/60 Hz

Manufacturing site:
Millipore SAS, 67120 Molsheim, France

For more information on your Milli-Q® system, please call your local representative or visit our website www.sigmaaldrich.com.

Intended use

The Milli-Q® EQ 7008/7016 system is intended to produce ultrapure (type 1) and pure water from a tap water source primarily for use in research and quality control in a variety of laboratories worldwide.

The product is designed to produce ultrapure and pure water with specific characteristics (refer to the requirements and specifications section) when it leaves the Q-POD® unit, provided that it is fed with water quality within specifications and properly maintained as required by the supplier.

We do not warrant the product for any specific application. It is up to the user to determine if the quality of the water produced by the product matches their expectations, fits with norms/legal requirements and to bear responsibility resulting from the usage of the water.

The product is not intended to produce: water for injection, water for dialysis, sterile water for irrigation or injection, bacteriostatic water for injection, sterile purified water in containers, and sterile water for injection in container or ingestion. The product is not intended to be used in explosive environments according to ATEX Directive – equipment & protective systems intended for use in potentially explosive atmospheres. In addition the product is not intended as a Medical Device, including In-Vitro Devices.

Installation components

Milli-Q® EQ 7008/7016 water system consists of at least 4 different components: water system (Milli-Q® EQ 7016 on the photographs below), tank, HMI (human machine interface) display and Q-POD® unit (Point of Dispense of ultrapure water).

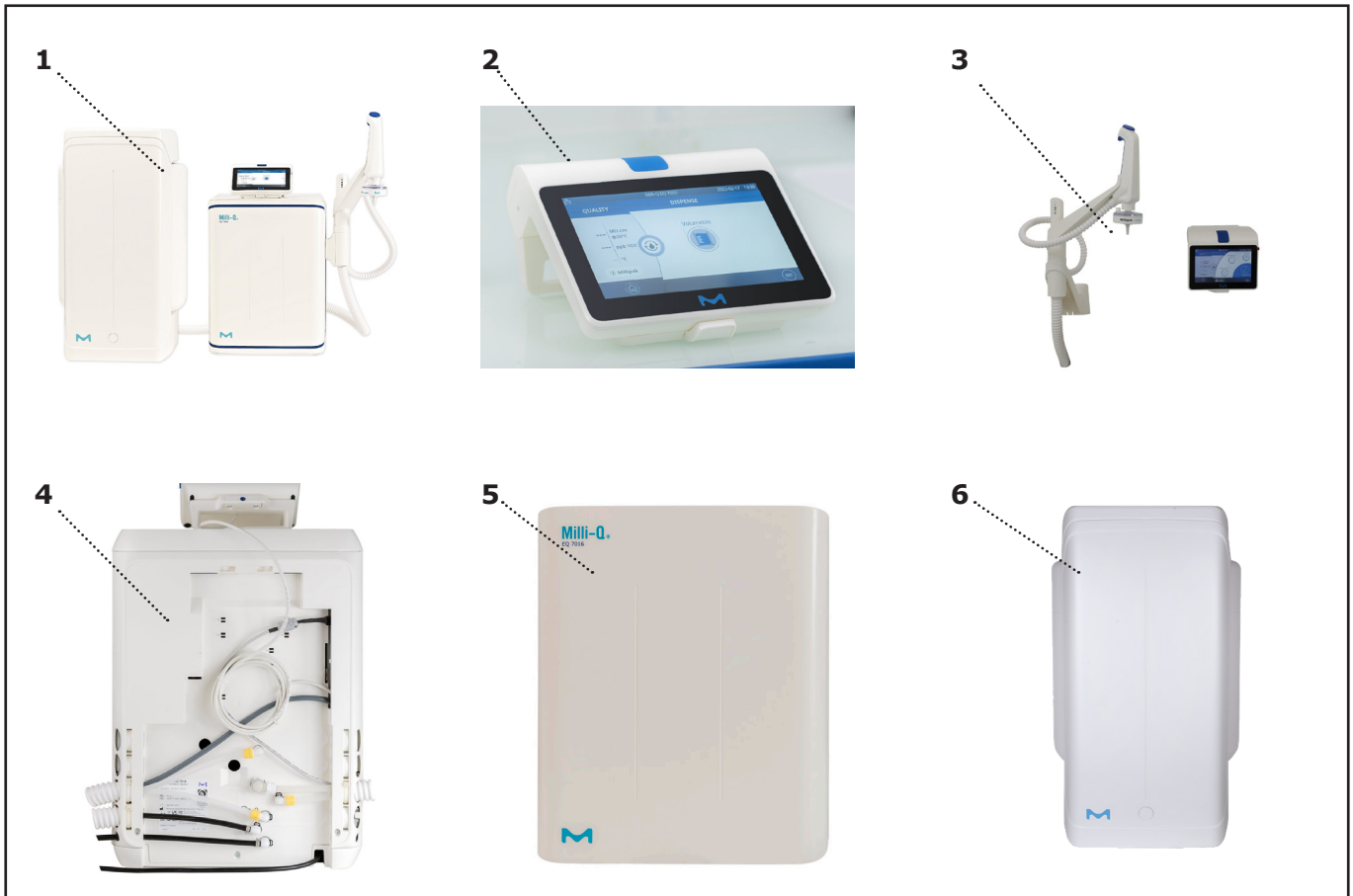

1	Front view of benchtop located Milli-Q® EQ 7016 with Q-POD® unit and HMI	4	Rear view of a Milli-Q® EQ 7016 system
2	HMI display (bench top solution)	5	Front cover
3	Front view of a wall mounted solution of a Milli-Q® EQ 7016 water system with Q-POD® unit and HMI	6	Storage tank (50 L capacity in this example)

Water process

The Milli-Q® EQ 7008/7016 water system manages the production and the distribution of ultrapure (Type 1) and pure water from a tap water source. It is composed of three different sections:

- Water purification unit manages the production of ultrapure water. It produces and fills the storage tank with RO quality water.
- Storage tank stores and maintains the RO water quality.
- Point of dispense (Q-POD® unit) manages the dispensing of ultrapure water. 'Check and Dispense' LEDs provide information about the performance of the system.

Production flow-schematic

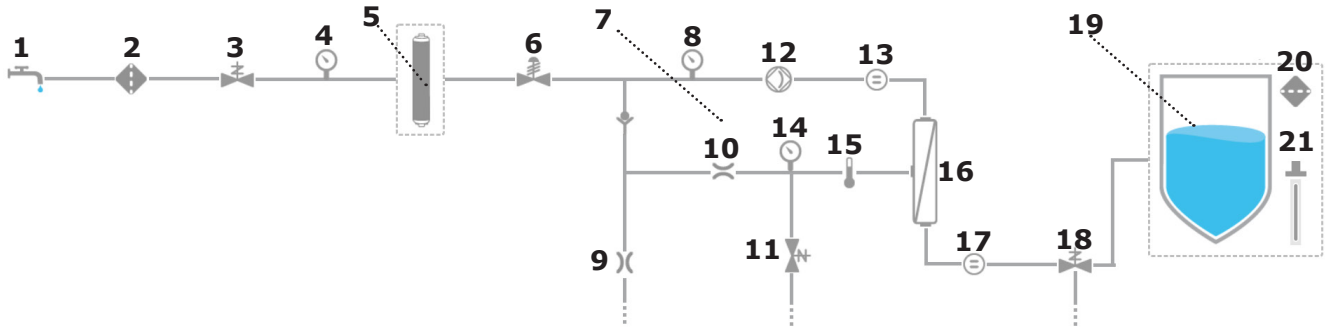

Distribution flow-schematic

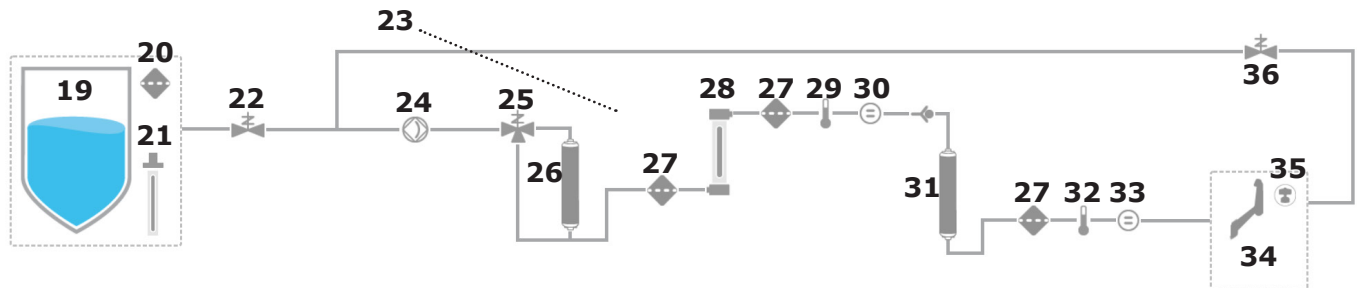

1	Tap feed water	19	Storage tank (25, 50 or 100 L)
2	Inlet strainer	20	Tank vent filter
3	Inlet solenoid valve	21	Automatic sanitization module [OPTION]
4	System feed pressure sensor	22	Distribution inlet solenoid valve
5	IPAK Gard® pretreatment pack	23	Recirculation loop
6	Pressure regulator	24	Distribution pump
7	RO recovery loop	25	TOC indicator 3-way valve
8	RO pump feed pressure sensor	26	IPAK Meta® polishing cartridge
9	Reverse osmosis (RO) reject capillary	27	Strainers
10	Flow controller	28	UV lamp
11	RO flush solenoid valve	29	Intermediate thermistor
12	RO pump	30	Intermediate resistivity cell
13	Feed conductivity cell	31	IPAK Quanta® polishing cartridge
14	RO pressure sensor	32	Milli-Q® product thermistor
15	Thermistor	33	Milli-Q® product resistivity cell
16	RO membrane (1 for Milli-Q® EQ 7008 or 2 for Milli-Q® EQ 7016 water systems)	34	Q-POD® unit
17	Permeate conductivity cell	35	Application POD-Pak
18	Permeate 3 way valve	36	Recirculation solenoid valve

This system uses potable tap water as feed and produces ultrapure (Type 1) delivered by 1 Q-POD® unit.

The system is divided into three sections. These are the production, the storage and the distribution.

Production: Tap water is first purified by the IPAK Gard® pretreatment pack which retains particles greater than 0.5 microns and removes chlorine. This helps to prevent clogging and/or chlorine oxidation of the reverse osmosis cartridge(s). Following the IPAK Gard® pretreatment pack, water is purified using Reverse Osmosis (RO). This is used to remove a large percentage of ions, particles, bacteria, and large size organic molecules. The water from this purification stage is called permeate water. This is the water that fills the storage tank.

Storage: The RO water is stored in high-quality polyethylene tank, which is equipped with a vent filter and as a potential option with the mercury-free ech₂o® automated sanitization module (ASM) lamp. The tank vent filter maintains the consistent purity of stored water and provides effective protection against airborne contaminants. The optional ech₂o® ASM lamp further protects the integrity of the stored water with regular exposure to bactericidal UV light.

Distribution: resistivity, TOC temperature and pressure are monitored. Tank is configured with a 2 or 5 meters connectors to the main production unit depending on the laboratory setting. The RO water stored in the tank, is purified one step further by the IPAK Meta® polishing cartridge composed of ion-exchange resins, removing the bulk of the ions. Water then flows to the UV oxidation lamp. Organic molecules are partially oxidized, resulting in a release of ions. These can then be captured in the next stage when the purified water enters the IPAK Quanta® polishing cartridge, composed of ion-exchange resins and synthetic activated carbon. The IPAK Meta® and IPAK Quanta® polishing cartridges always need to be replaced together to ensure optimal purification down to trace levels of contaminants. Throughout the purification steps, quality parameters are monitored with resistivity and temperature sensors and the TOC (total oxidizable carbon) indicator. The TOC indicator gives an indication of the total organic content measured in ppb at the point of distribution.

The **Q-POD® dispenser** is detachable from its support. The dispenser uses an adjustable selector wheel which allows dispensing of water at either a low, medium or high flow, from 0.5 to up to higher than 1.8 L/min. At the outlet of the dispenser, the final purification is performed by the application-specific POD-Pak.

The **large 7" touchscreen** on the HMI offers a wide range of applications for users. It also has a USB port to easily export data.





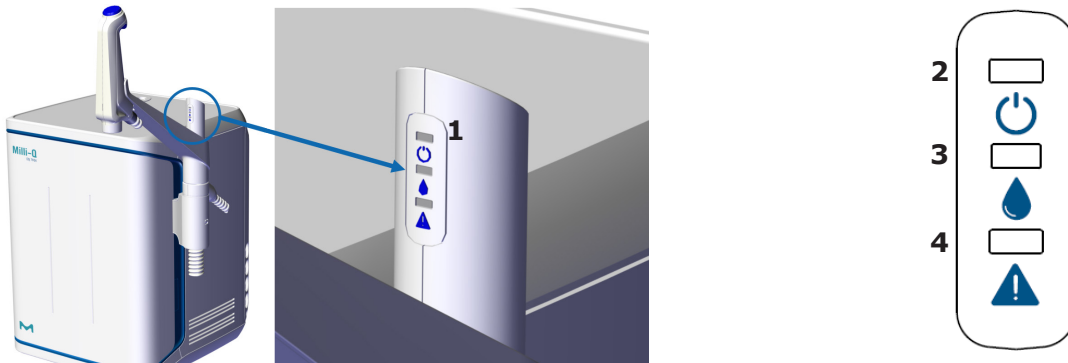



LEDs overview

On the Q-POD® unit, 3 'check and dispense' LEDs indicate the different states of the system:



1	LEDs on the Q-POD® mast	3	Water Quality LED
2	System Power LED	4	System Alarm / Alert LED

LEDs description

LED	Meaning
	The system is powered on.
 	STEADY: The water quality fits the requirements (water quality values are below alarm setpoints). BREATHING: The system is in recirculation mode.
 	A water quality alarm is raised.
 	An alert or alarm is raised.
 	An alarm stop has occurred. A portion or all of the system has stopped for safety reason.

Note:

- The 3 LEDs light up when powering the system on.
- The 3 LEDs are breathing in case of maintenance (see page 26)

QUICK START (after installation performed by a qualified field service representative)

Exit screensaver

A screensaver automatically appears after a few minutes if the HMI touchscreen is not used.

Screensaver

Tap anywhere on the screen or initiate a manual dispense by pressing the dispenser wheel to exit the screensaver.

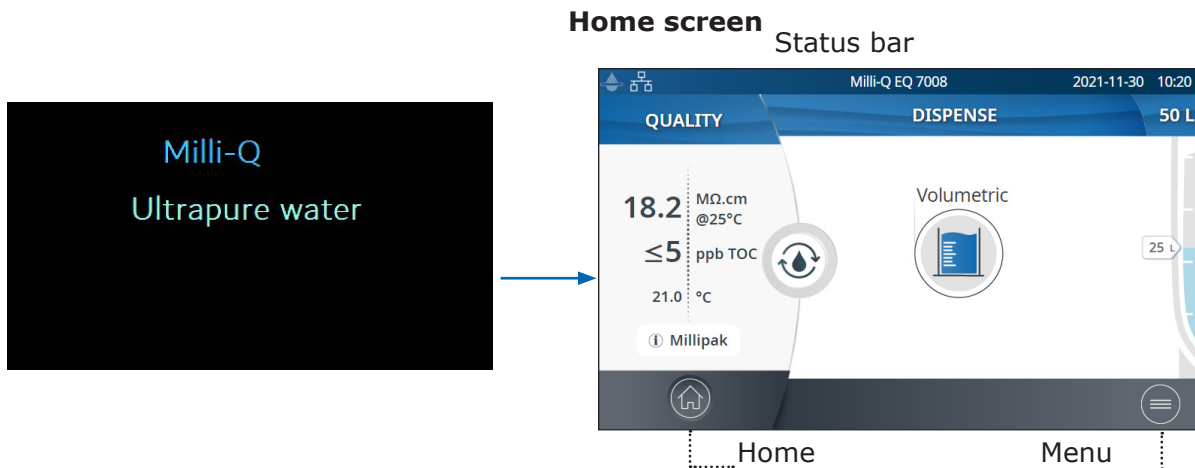

Dispense ultrapure water

It is a good practice to recirculate water for a minute or longer before dispensing. To do this, press on the recirculation icon, this also refreshes the water quality parameters:

- Product resistivity
- TOC
- Temperature

Recirculate



There are several options to dispense ultrapure water:

Manual Dispensing

To start dispensing in low flow, turn the dispense wheel one notch counter-clockwise.

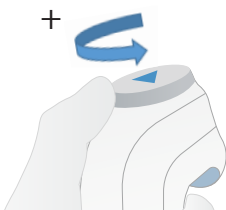

Adjust flowrate

To increase the flow rate keep turning the wheel counter-clockwise until full flow is reached. To decrease the flow rate, turn the wheel clockwise.

Low flow  Full flow 



To start dispensing at full flow, press down on the dispense wheel.

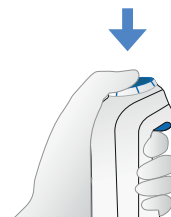

Stop

To stop dispensing, press down on the wheel or rotate the wheel clockwise until no more water flows from the dispenser.



Volumetric Dispensing

Enables a user to auto dispense a pre-selected volume (10mL up to 25L using the custom value

Note: Make sure there is enough water in the storage tank before dispensing.
The water level in the storage tank is displayed on the right side of the HMI home screen:

Select the volume to dispense, press ok to validate. The input value can be customized, go to page 21 [Settings > System configuration](#)

Press the Play button to start dispensing the pre-selected volume.



The system will automatically stop once the requested volume is reached.

Water Quality values

When the dispensing is finished, the resistivity and temperature are instantly displayed on the left side of the HMI. Ninety seconds later a new TOC value is displayed.



The green LED is lit if the water quality is within specifications.

If the calculated TOC value is from 0 to 5 ppb, ≤ 5 ppb will be displayed

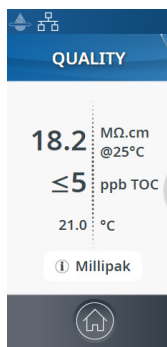

If the calculated TOC value is from 6 to 10 ppb, ≤ 10 ppb will be displayed

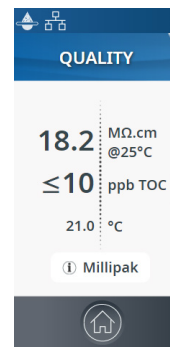

When TOC values are greater than 10 ppb, then integer values are displayed (example: 13 ppb).

Dispense archiving



After each time a dispensing is done, the water quality values are automatically archived and can be retrieved in the history report section available in the information menu. Go to page 16 [Information > History](#) for further information.

View & manage Alerts and Alarms

Alerts give you advanced warning when maintenance is required and alarms notify you when the system has encountered a technical issue.

 Yellow LED is displayed when an alert is raised.

 Red LED is displayed when an alarm is raised.

Press on the alert  or the alarm  icon present in the bottom bar to display the alert(s) or/and alarm(s) which are active.

Note: The notification number indicates how many active alarms are present. When there are no active alerts or alarms, the relevant icon disappears.

Select a specific alert or alarm to get further information and to better understand the root cause. Advice is provided in the information section to help the user troubleshoot.

If the issue is not resolved and depending upon the alert and alarm, either select the **Contact** tab to find the technical support hotline number for further assistance or the **Order** tab containing ordering information when applicable.

In order to protect the system and user applications, alarms of a serious nature will automatically stop the system from dispensing water.

Note: These are displayed on the screensaver to tell the user when the system is not in active use

Alerts provide advanced warning of any maintenance actions that will be required. Press Close to cancel the alert for 24 hours. Press Start on the HMI in order to begin a series of steps which will clear the alert for a long time.

An **Order** tab appears when an alert is caused by a consumable needing replacement soon. The Order tab contains catalogue numbers of the consumable(s).

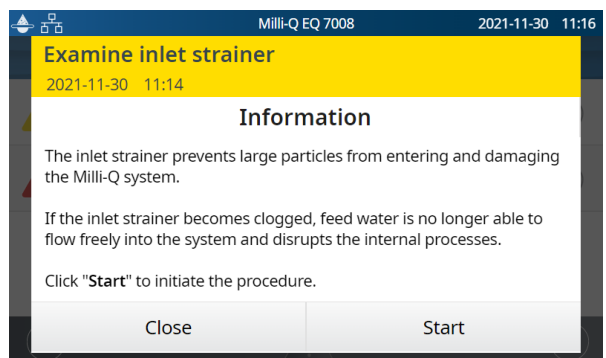
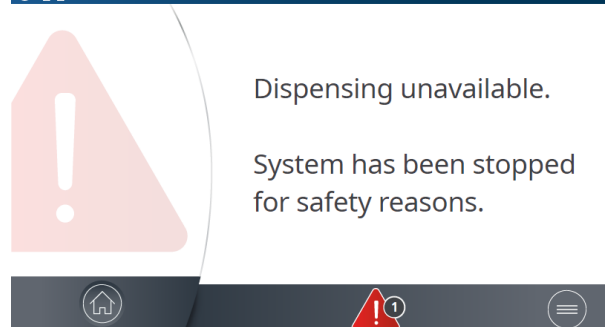
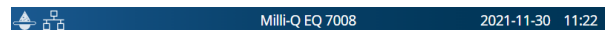
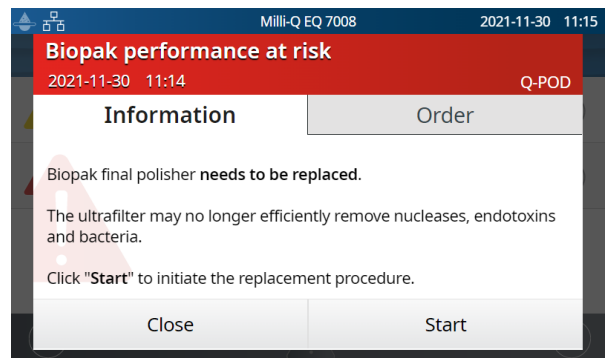
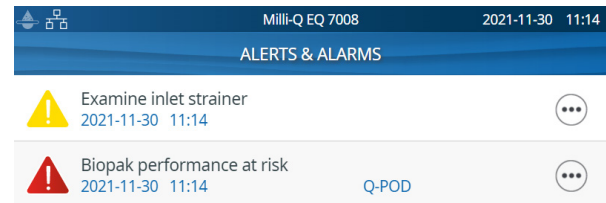

Navigate the screen interface

HOME SCREEN

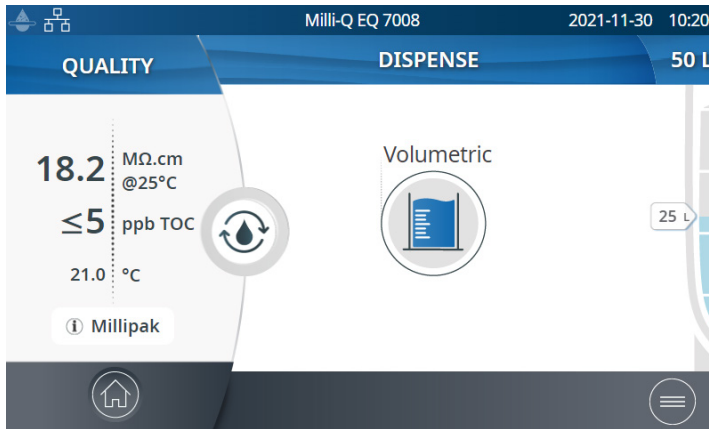

- Water quality information
- Dispensing functions
- Alerts & Alarms (when generated by the system)
- Water level in tank
- Recirculation start icon

MAIN MENUS



- Settings
- Information
- Maintenance
- Consumables
- Login

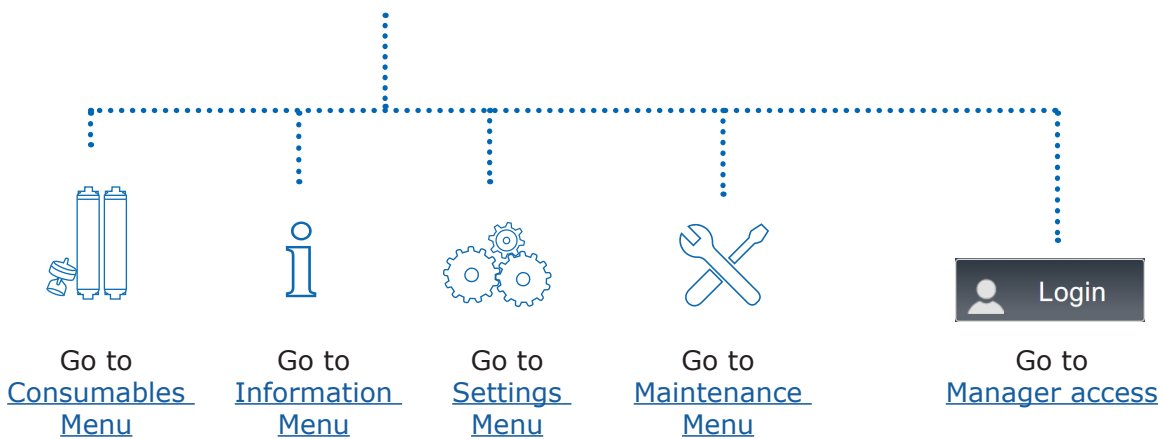

Apps

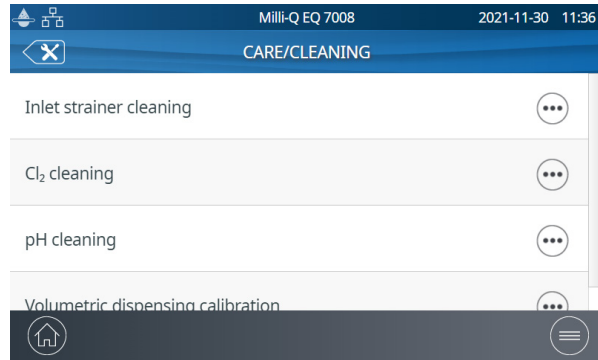

When there are multiple lines, a scroll bar is present to swipe up and down

● ● Indicates how many screens are present and where you are.
Swipe left & right anywhere on screen to switch between screens.

Pops-up screens

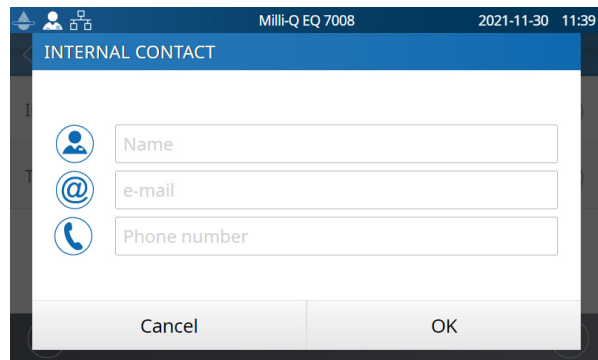
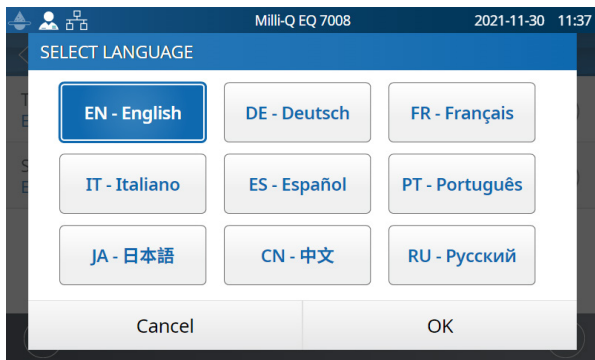

When a text box is selected, the keypad will automatically appear.

To remove the keypad click on  or on any zone outside the keypad.



Note: When in a menu or app level screen, the system automatically goes to the home screen after 1 minute of inactivity.

When a pop-up type of screen is displayed, the system does not automatically return to the home screen after 1 minute of inactivity.

Collect RO water from the tank front valve

Follow the steps below to collect RO water from the front of the tank.



1. Clean the tank front valve : use a lint free cloth towel, wet it with the cleaning agent and wipe down all exposed exterior surfaces of the valve. Cleaning agents that can be used include :
 - KLERCIDE™ Isopropanol 70% or equivalent composition
 - SPOR-KLENZ® (Ready to use) or equivalent composition

Be sure to follow the safety precautions listed with the recommended cleaning agent.

2. Open the front valve and discard the first liter of water dispensed from the tank front valve.
3. Open the front valve to dispense water for your needs.
4. Close the front tank valve.
5. Clean the front tank valve again using one of the cleaning agents listed above.

CONSUMABLE MENU



Viewing Consumables Status

By using different colors, the status of installed consumables are indicated.

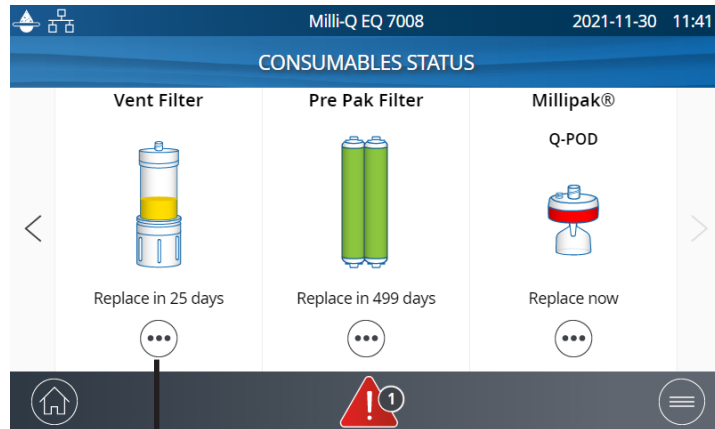

LEDs



Green: no action required
Yellow: notice for a maintenance action
Red: maintenance required!

Press on the  icon to get a description of the consumable, the ordering information, and the consumable's ID.

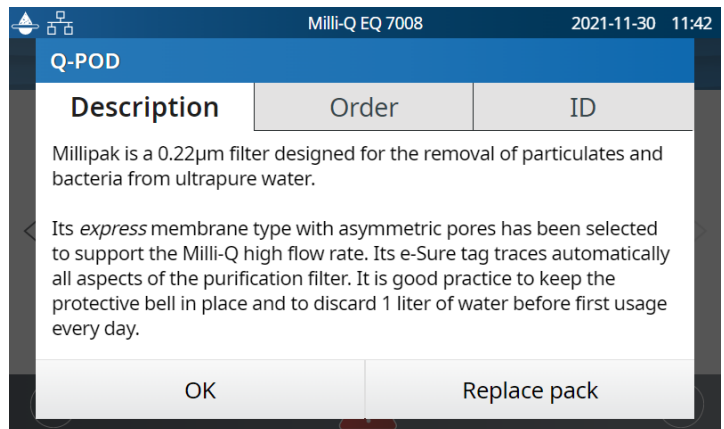

Certificates of quality are available online www.mymilliqconsumables.com

All cartridges have been designed to be easily replaced by a user. A shortcut to access to the replacement wizard is available by clicking on the "Replace pack" button in the pop-up.

Note: In case of application of PrePak filter pretreatment pack (PRPK00001 or PRPK000A1), it is recommended to replace the PrePak at the same time as the IPAK Gard® pretreatment pack.

Consumables identification with card reading

For each consumable, the following pieces of information are available:

- lot number
- catalog number
- installation date

The IPAK Quanta® and Meta® polishing cartridges, IPAK Gard® pretreatment pack and application POD-Paks information is automatically registered during their installation.



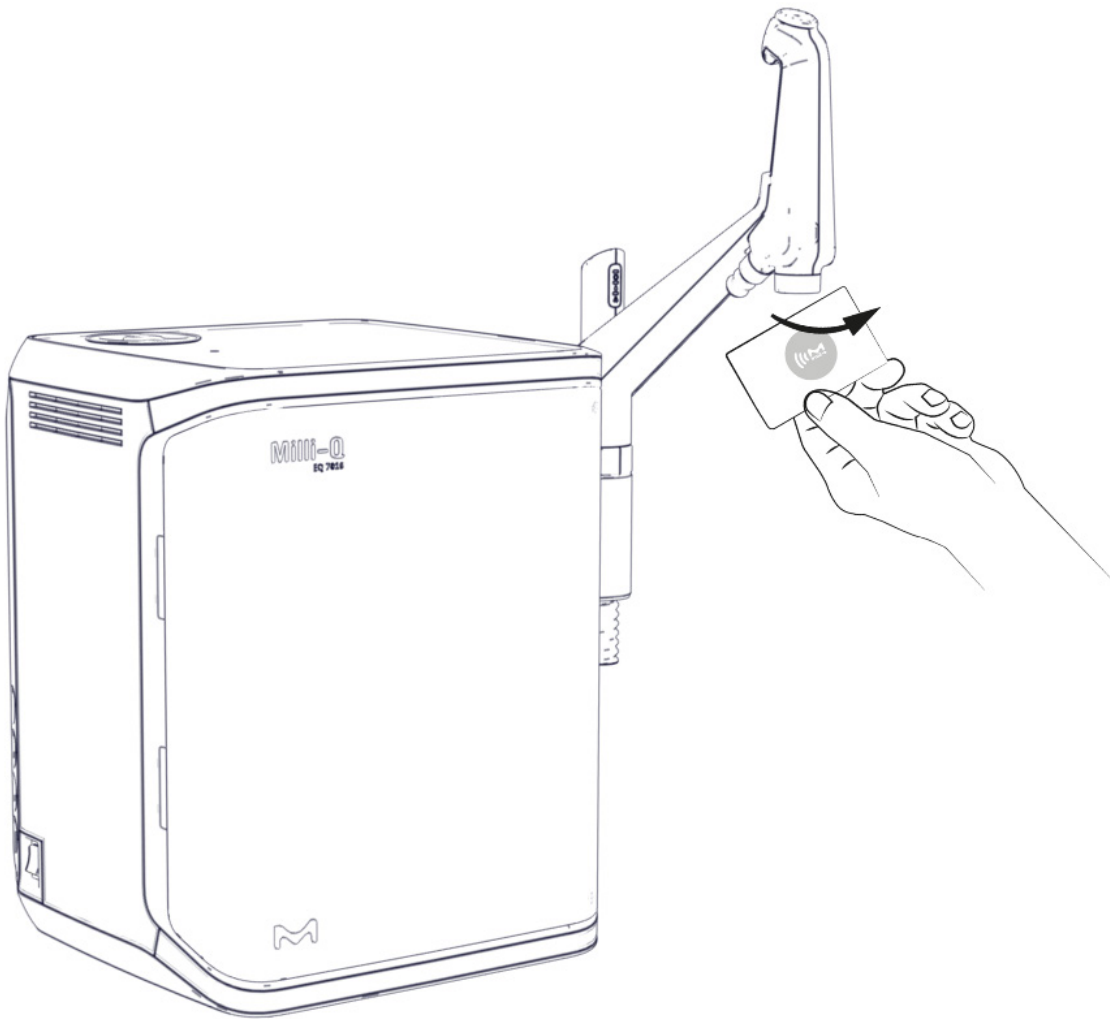

The tank vent filter comes with a RFID card enabling the transfer of the data into the system. Go to page 26 [Maintenance>Consumables installation wizard](#) for further information.



INFORMATION MENU

This menu provides system information and system status. Dispensing is available while in this menu.

Available apps:

 System	 History	 Troubleshooting
 Contacts	 Flow schematic	

System



Find system details

Select *System ID* to find the information on the water system model and installation details.

History

2 user reports exist:

- [Daily quality measures report](#)

Each row represents a day (midnight to midnight) and is dated. It contains daily averages for product resistivity, TOC and temperature dispensed each day. Also included is the total volume dispensed during the day.

- [Dispensing events report](#)

Each row contains a record of a single dispensing. It is an archive of all the dispense reports.

To export data or preview a graph:

1. Select a time period of interest with a start and end date.

2. A graph pre-view of the last 30 records is available on the HMI screen.

3. Export the report in .ods (open document source) format to visualize the full data and integrate them into a data management system.

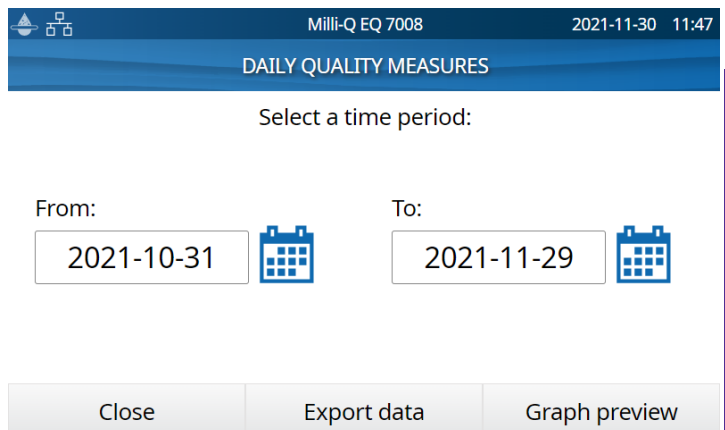

Note: A complete history report with all system activity is available. By default it is only available when logged-in as the system manager. This can be modified by de-activating the system manager profile in the settings menu, go to page 19 [Settings>Manager access](#).

Flow schematics

Flow schematics are graphic representations of the hydraulic components of the water purification system. Components change color depending on the state and system status.

Grey - inactive Blue - active

Yellow - maintenance alert Red - sensor error or consumable replacement overdue alarm

Production flow schematic shows all components and operating values used to produce RO quality water and to store it.

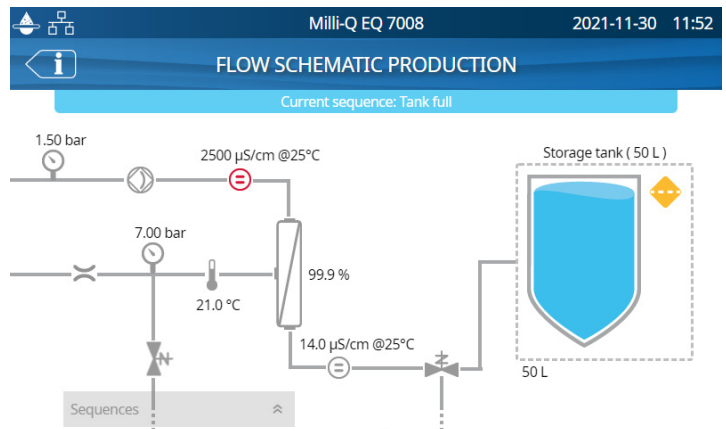

Distribution flow schematic shows all components and values used to purify RO quality water from the storage tank into ultrapure water that is dispensed

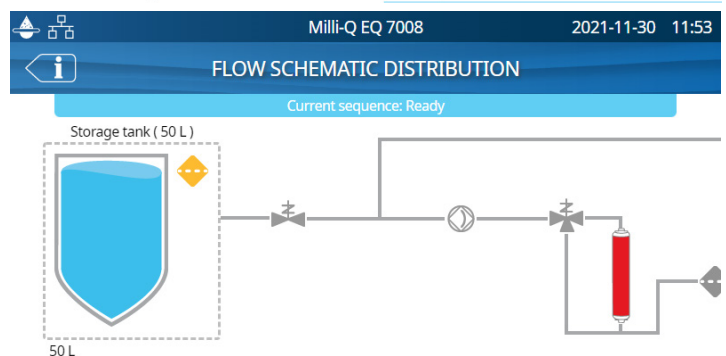

Troubleshooting

Used to access a diagnostic summary.

Open this app to get information which can be communicated with a technical service representative in case of troubleshooting.

- System information & last service visit
- Water quality & consumables (installed dates)
- Active alerts, alarms & auto-test results
- Diagnostics

Contacts

To edit contact information, login as the system manager, go to page 19 [Settings>Manager access](#). The user parameters are used on various reports generated by the system and can quickly help users identify the right contact for any questions or issues.

Internal contact Responsible for system configuration & quality settings
Technical support In case of troubleshooting

SETTINGS MENU



Different settings are available to customize the water purification system operation. Depending on the user profile (end-user operator / system manager) some of the settings will have either read-only or read & write access.

Available apps:

System Configuration	HMI configuration	Date, Time & Language	Password
Alarm Configuration	Connectivity	Units	

Note: Dispensing while in this menu is not available.

The table below shows the list of settings. A green tick mark symbol means that the setting can be modified.

Settings		End-user	System Manager
System Configuration	Lab close	✓	✓
	Screen saver	Read only	✓
	Water sensor	Read only	✓
	Alarm relay	Read only	✓
	Foot pedal	Read only	✓
	Periodic RO flush check time	Read only	✓
	Tank capacity	Read only	Read only
	Tank refill setpoint	Read only	✓
	ech ₂ o ASM lamp	Read only	✓
	Recirculation duration	Read only	Read only
	Safety flow stop	Read only	✓
	Custom volume	✓	✓
Connectivity	Local network	Read only	✓
Alarm configuration	Permeate conductivity	Read only	✓
	RO ionic rejection	Read only	✓
	RO feed conductivity RO high	Read only	✓
	RO feed conductivity tap high	Read only	✓
	Inlet strainer clean	Read only	✓
	Cl ₂ clean	Read only	✓
	Pre Pak filter		✓
	IPAK Gard (lifetime)		✓
	IPAK Gard (volume)		✓
	Vent filter		✓
Tank empty	Read only	✓	

Settings		End-user	System Manager
Alarm configuration	Ultrapure resistivity	Read only	✓
	Ultrapure TOC	Read only	✓
	IPAK polishing cartridges		✓
	Millipak		✓
	Millipak Gold		✓
	LC-pak		✓
	VOC-pak		✓
	EDS-pak		✓
HMI configuration	Brightness	✓	✓
	Buzzer	Read only	✓
Date, Time & Language	Time zone - Date - Time	Read only	✓
	Language	Read only	✓
Password	System manager		✓
Units	Resistivity / Conductivity	Read only	✓
	Temperature	Read only	✓
	Storage tank	Read only	✓
	Temperature compensation mode	Read only	✓
	Pressure	Read only	✓

Manager access (& password)

Login as a Manager

1. Press on the menu button  from the Home page.



2. Press on *Login*.

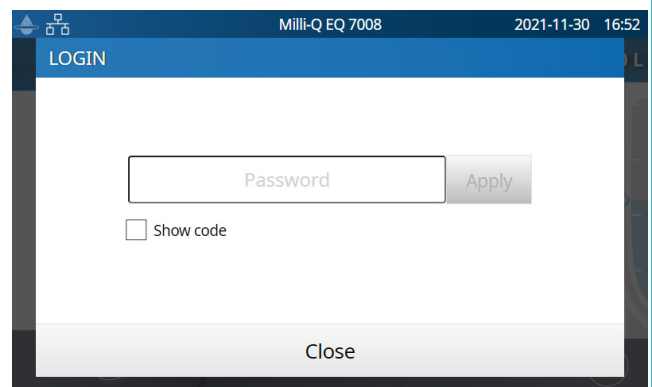

3. Enter system manager password.

To display & see the password while typing, select the **Show code** checkbox.

Once logged-in, the manager icon  is displayed in the top left corner.

If a manual logout is not performed, the system manager profile will be automatically logged out after 1 hour of inactivity.

Note: By default the Manager password is active. The default password is **PASS**

Log out as a Manager

1. Press on the menu button .
2. Press on **Logout**.

Modify system manager settings

This can only be done when logged-in as a manager.

In the **Password** app:

1. Deactivate/re-activate the manager password through the password activation slider button.
2. If required, change the password.

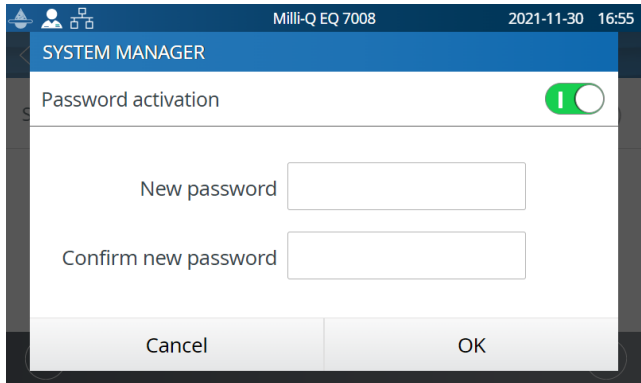

Note: Contact your technical service representative if the password is lost or forgotten.

Important! Deactivating the system manager profile will allow any user to have read & write access with all settings.

System configuration

Lab close

If the water system is not going to be used for more than 3 continuous days, then the Lab Close mode can be activated in order to save energy. Before starting this mode, the tank is manually emptied. During this mode, periodic recirculation occurs once a day instead of once per hour. A few hours before the completion of this mode, the tank is automatically refilled.

Follow the self-guided wizard to activate the lab close. It is important to realise that it can take a long time to manually empty the tank before starting a lab close mode. The time it takes depends upon the capacity and volume of water within the tank. It may take up to 1 hour for a 100 L tank.

In case of multi system configuration with one tank:

- If 1 Milli-Q® EQ 7000 water system is connected to 1/2 Milli-Q® EQ 7008/7016 water system(s), lab close mode shall only be toggled on Milli-Q® EQ 7000 water system (ASM highly recommended). In case of quality alarm/alert upon lab reopening, simply empty the tank through POD dispensing.
- If the multi system configuration is composed of 2 Milli-Q® EQ 7008/7016 water systems, both lab close wizards shall be activated simultaneously on both systems step by step.

Safety flow stop

The safety flow stop is a precautionary measure that prevents Q-POD® unit from dispensing after having continuously delivered water for a certain duration. Adjust to the preferred time by using the arrows or click on the box in the centre of the screen in order to access the keypad.



This setting will not impact volumetric dispensing functions.

Screensaver

This is the maximum duration of inactivity on the HMI before the screensaver starts.

1. Activate / deactivate via the slider button.
2. Adjust to the preferred time by using the arrows or click on the box to access the keypad.

By default the screensaver is active and the timer is set to 5 minutes.

Periodic RO flush check time

By default, at 1 a.m. the system rinses the RO cartridge(s) for 3 minutes unless the system has operated more than 1 hour in the past 24 hours. This is done to maintain water purity and freshness. The time of day for this event can be adjusted. The duration (3 minutes) can not be adjusted.

Custom Volume

This is the volume you can customize to be able to dispense with the Volumetric Dispensing function. The volume can be set from 100 to 25000 mL in 100 mL increments.

HMI configuration

This app allows a user to configure all parameters specific to the HMI.

Screen brightness

Adjust to the preferred brightness from 1 to 7. You can use the arrows or click on the box to access the keypad and type-in the value.

Buzzer

The Q-POD® unit mast can emit a sound when alerts/alarms are active. This can be activated or deactivated using the slider button. By default, the sound is deactivated.

Accessories

Water sensor

A water sensor can be interfaced with the water system using a cable. If the sensor detects water, both the production and the distribution sections of the system immediately stop. Up to 3 water sensors can be interfaced.



Foot pedal

The foot pedal is connected to the system. In the HMI configuration app, activate the foot pedal via the slider button.

Dispense using the foot pedal:

1. Press once and release to dispense in full flow.
2. Press once to stop the dispensing.

Note: The foot pedal may also be used to dispense water using the volumetric dispensing mode.



Washer Distribution kit

Contains a pump and pressure switch. Used to pump water directly from the storage tank to an application such as a dishwasher. It does not interface with the water system. It can be wall-mounted.

Note : A specific tank vent filter (designated with the letters HF) has to be used for such high flow rate application.



Alarm relay

An alarm relay cable can be interfaced with the water system. All or some alarm messages can be selected to trigger the alarm relay. Select the alarm(s) that can activate the relay.

Note : The Alarm relay selection setting appears in lab manager mode provided Alarm relay in ON.

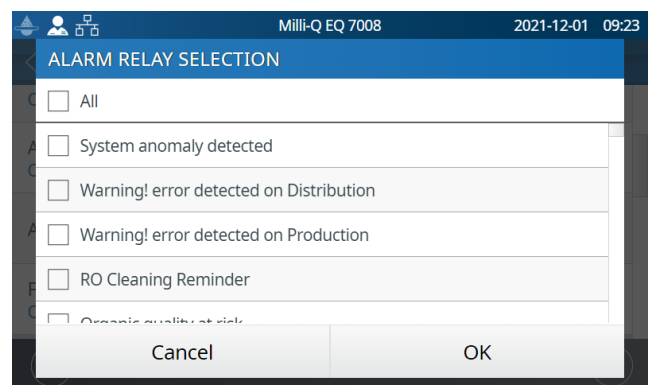

Note: Please go to page 42 and see the [Requirements & Specification>Ordering information](#) to get the catalog numbers.

Alarm configuration

Adjust the alarm set points by either clicking on the arrows or alternatively, click in the box to access the keypad and directly type-in the value.

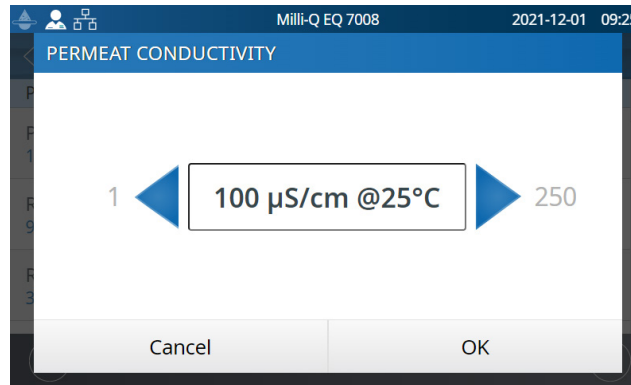

Alarm and unit	By-default value	Adjustable range
(RO) Permeate conductivity (µS/cm @25°C)	100	1 - 250
RO ionic rejection (%)	92.0	0 - 99.9
RO feed conductivity RO high (µS/cm @25°C)	3400	1 - 4000
RO feed conductivity tap high (µS/cm @25°C)	2000	1 - 2000
Inlet strainer clean (days)	365	1 - 999
Cl ₂ clean (days)	90	1 - 365
PrePak Filter (days)	365	1 - 365
IPAK Gard (days)	365	1 - 365
IPAK Gard (L)	30000	27000-30000
(tank) Vent Filter (days)	365	1 - 365
Tank empty (%)	0	0 - 50
Ultrapure resistivity (MΩ.cm @25°C)	16.5	1 - 18.2
Ultrapure TOC (ppb)	500.0	1 - 999
IPAK polishing cartridges (days)	365	0 - 365
Millipak® (0.22 µm filter) (days)	182	30 - 182
Millipak® Gold (0.22 µm sterile filter) (days)	182	30 - 182
LC-Pak (L)	500	500 - 550
VOC-Pak (L)	300	300 - 350
EDS-Pak (L)	300	300 - 350

It is recommended to clean the inlet strainer once a year to avoid it becoming clogged. Depending on the amount of debris in the feed water, the inlet strainer clean frequency can be adjusted.

Cartridges should be changed when the system alerts the user. Two thresholds can be triggered for the replacement of the IPAK Gard® pretreatment pack. One threshold is the number of days that have elapsed since it was installed. The other is the volume of water processed by the cartridge.

Connectivity

The system offers the possibility to be connected to a laptop with a fixed IP address or to your local network (DHCP enabled or DHCP disabled) via an Ethernet port. The IP address of the system can be seen by swiping the screen top to bottom. The DHCP (Dynamic Host Configuration Protocol) is an "automatic configuration" of a device anytime it connects to an IP Network. This "automatic configuration" is called allocation. The system is automatically recognized and configured so that the networks resources can be used. Check with your local IT resources which type of connection is best suited to you.

Change network connection settings

1. For a direct connection, change the network settings if necessary (water system default IP address is: 192.168.1.69).
2. For network connection, activate DHCP via the DHCP activation button.

Duplicate user interface in a browser

Once connected:

1. Go to your browser. For best browsing performance, Google Chrome™ browser is recommended.
2. Enter the IP address of your system which can be found in the connectivity pop-up screen.

Note: The view from a laptop enables a user to view the HMI display remotely. Dispensing can not be done remotely for safety reason.

Date Time & Language

Date

Calendar date representations are shown in the ISO® 8601 format "2018-11-06" [YYYY-MM-DD]. [YYYY] indicates a four-digit year. [MM] indicates a two-digit month of the year, 01 through 12. [DD] indicates a two-digit day of that month, 01 through 31.

Start by setting the year:

1. Click on the *month & year* title, this displays months and only the year as a title. Click again on the *year* title to display years.
2. Select the year. After selecting the year, the month selection is automatically displayed.
3. Select the month. After selecting the month, the day selection is automatically displayed.
4. Finally select the day to confirm the date setting.

Time ZONE

1. Select the continental or oceanic zone you are in on the left. This updates the right-hand side with all the major cities within this time zone.
2. Select the appropriate city. If you have not found a city, make sure you are in the right time zone.

The Milli-Q® system is now configured to display current local time and automatically updates when daylight saving time applies.

Time

The time is set and displayed in a 24h clock format. A time of day is written in the 24-hour notation in the form hh:mm (for example 14:23), where hh (00 to 23) is the number of full hours that have passed since midnight, mm (00 to 59) is the number of full minutes that have passed since the last full hour.

Language

There are 9 languages available: Chinese / English / French / German / Italian / Spanish / Brazilian Portuguese / Japanese / Russian

Units

Units can be formatted to local needs:

Resistivity / Conductivity	MΩ.cm	μS/cm
Temperature	°C	°F
Storage tank level	L	%
Pressure	Bar / kPa / psi	

Select and press on the unit of interest. The selected unit will appear in blue. Press "OK" to confirm selection and exit the pop-up.

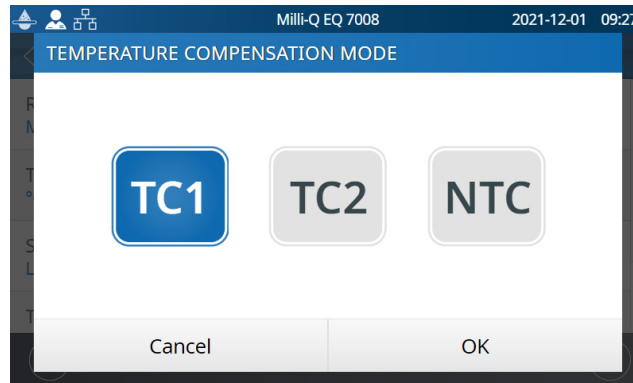

Temperature compensation mode

It is possible to show non-temperature compensated resistivity or non-temperature compensated conductivity. Temperature compensation is a way of standardizing resistivity or conductivity to measurements that would be seen if the water temperature was 25°C.

Select the preferred mode of temperature compensation:

TC1	<p>By default TC1 mode is selected.</p> <p>The resistivity or conductivity values are temperature compensated to 25°C. The values are normalised. The system firmware eliminates small fluctuations of temperature compensated resistivity or conductivity due to the fact that these two parameters are not measured exactly at the same time.</p>
TC2	<p>The actual temperature compensated resistivity or conductivity values are displayed. In some operating conditions the feed water can be warmer or cooler than the water temperature inside the system. As a result, this can cause small fluctuations of the resistivity and conductivity values. Resistivity values could fluctuate for ultrapure water between <i>18.0 MΩ.cm and 18.4 MΩ.cm @25°C</i> while the actual resistivity is <i>18.2 MΩ.cm @25°C</i>.</p>
NTC	<p>No Temperature Compensation. The temperature compensation is off. The displayed resistivity or conductivity is not temperature compensated. The temperature of the water is shown at the same time as the non-temperature compensated resistivity or conductivity value.</p>

MAINTENANCE MENU

The maintenance of the system is easy thanks to the step-by-step instructions contained in the wizards. In addition, a new cartridge design means that pack removal and installation in the system unit is quick and effortless.

Available apps:



Note: Dispensing in this menu is only available in the applicable wizards.



Maintenance screens



Maintenance ongoing from the HMI.

Consumable installation wizards

A maintenance wizard can be accessed in different ways:

1. Through the Maintenance menu 
2. A shortcut from an Alert  or Alarm  pop-up.
3. A shortcut from a consumable pop-up.

IPAK Quanta® and IPAK Meta® polishing cartridges replacement

1. Select **Install consumables** app and click on *Install IPAK Meta & Quanta*.
2. Follow the self-guided wizard.

IPAK Meta® & IPAK Quanta® polishing cartridges both need to be replaced at the same time.

This is because they have been designed to achieve the expected best-in-class Milli-Q® ultra-pure water with the unique combination of the proven Jetpore® ion-exchange resin and the innovative IQnano™ resin. *Only together*, and when integrated into the hydraulic design of the system, they can purify water to remove contaminants down to their traces from a pre-treated source.

IPAK Meta & Quanta consumable kit: IPAKKITA1



Note: 30 L of water are required in the storage tank to rinse newly installed IPAK Meta® and IPAK Quanta® polishing cartridges. If there is not enough water present, the wizard will finish but the cartridges may not be fully rinsed. The remaining rinse will need to be performed manually.

Important! During the physical pack replacement in the water purification unit, both cartridges must first be removed before installing the new set.

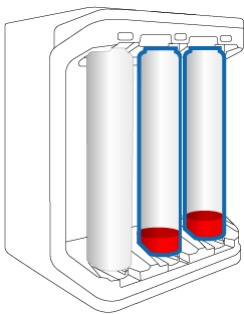

Remove **BOTH** old cartridges.

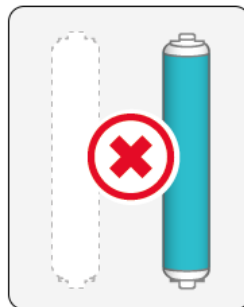
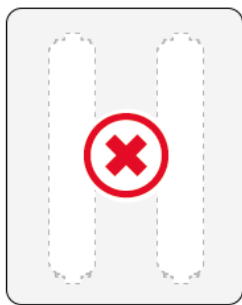

Then insert new cartridges.

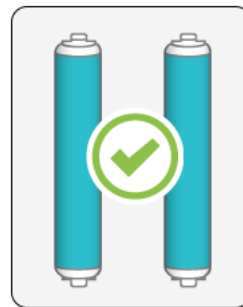

IPAK Gard® pretreatment pack replacement

1. Select the **Install consumables** app and click on *IPAK Gard installation*.
2. Follow the self-guided wizard.



Note 1: When properly installed, the **e-Sure)))** symbol should face inwards.

Note 2: If the sound has been activated, it is normal to hear a buzzer when changing the consumables. This is temporary and is only present when the IPAK cartridges or POD-Pak are removed. As soon as they are put back into place, the buzzer will stop.

Note 3: It is recommended to replace the tank vent filter when replacing the IPAK Gard® pretreatment pack.

Application POD-Pak installation

1. Select **Install consumables** app and click on *Application POD-Pak installation*.
2. Select the POD-Pak to be installed, click on the *Next* button and follow the self-guided wizard.

When installing the POD-Pak, twist and turn it until it stops. Do not overtighten.

3. Rinsing must be performed manually to complete the installation as indicated on the screen. When completed press "Finish" to exit the wizard.

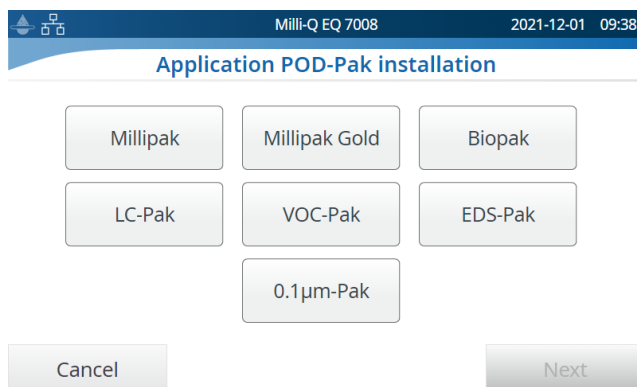

Note: All certificates of quality are available online.

Visit www.mymilliqconsumables.com

Storage tank vent filter replacement

As a first step, remove the magnetically held top cover of the storage tank. Once done, the vent filter is seen on the right side of the circular lid of the storage tank. The vent filter located at the top of the storage tank can easily be removed and replaced as described below. When ordered, it comes with a RFID card that is used to register its installation.

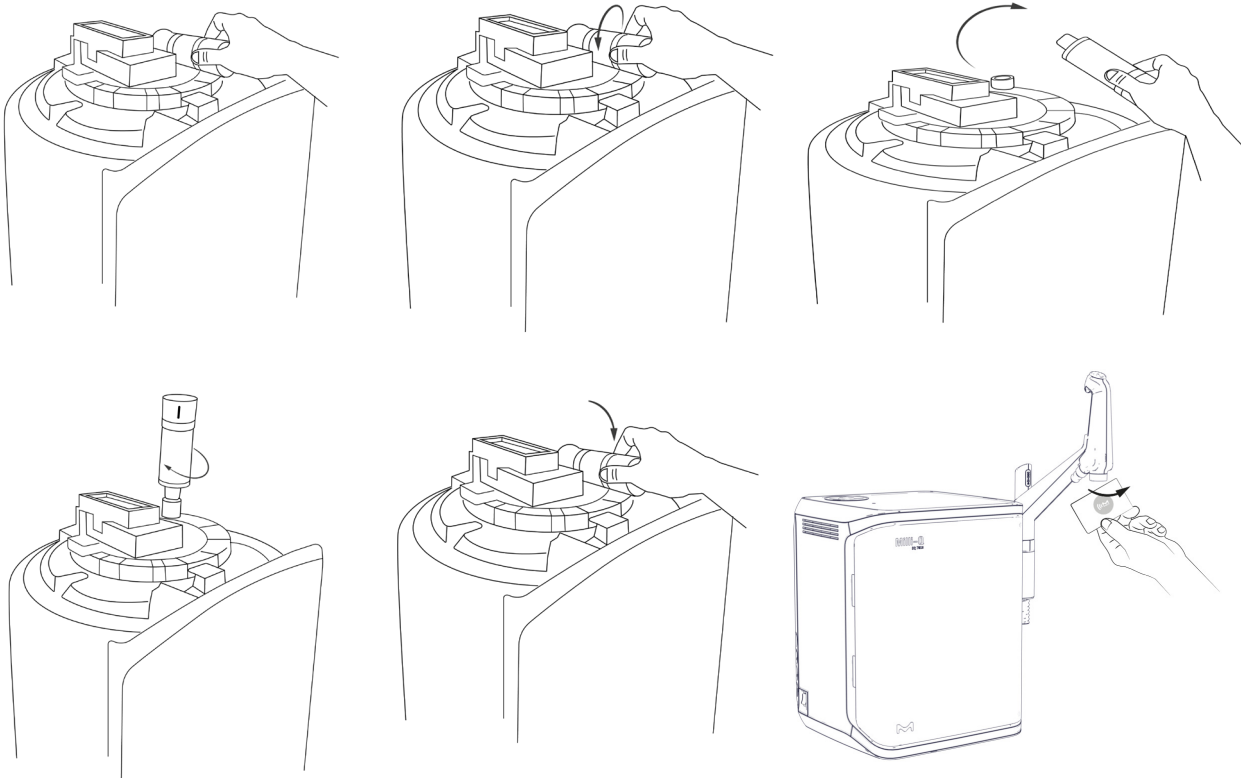

Important! Due to a UV lamp located inside the storage tank, never remove the circular lid.

You can register the vent filter details by selecting the *Install consumables* app and selecting the vent filter:

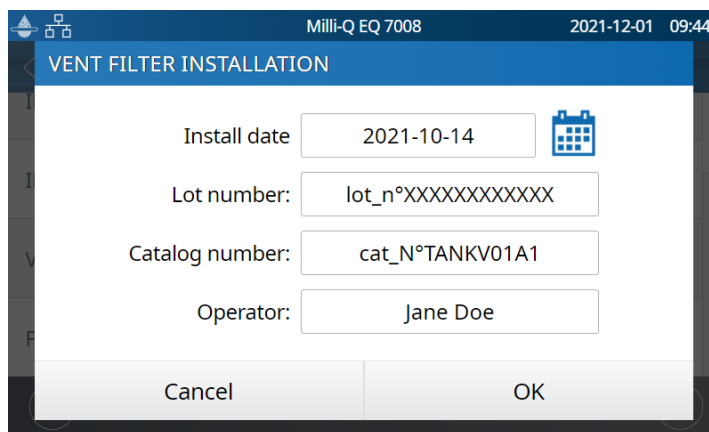

You can either manually type in or register the data by scanning the RFID card on the e-Sure tag reader located on the handle of the Q-POD® dispenser unit. If you manually type in the data, replace "XXXXXXXXXXXX" by the actual lot number of the vent filter. You can find the lot number written on the label of the box.

Cleaning & Sanitization

Cleaning the inlet strainer

The purpose of the inlet strainer is to prevent large particles from entering the Milli-Q® system. If the inlet strainer becomes clogged, then feed water does not flow freely to the system.

Select the **Care/Cleaning** app and click on *Inlet strainer clean*. Follow the self-guided wizards.

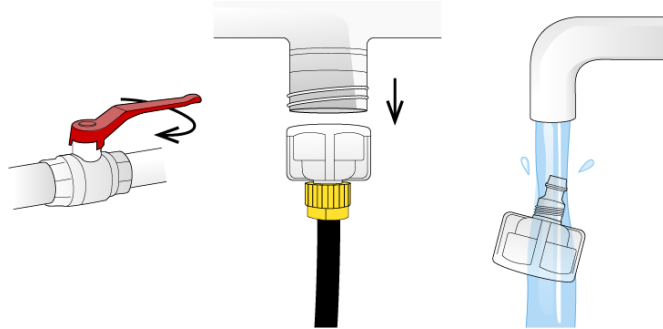

Cl₂ Cleaning

Follow the self guided wizard. Contact your service representative for further information. It is recommended to perform a Cl₂ cleaning every 90 days.

pH Cleaning

Follow the self guided wizard. Contact your service representative for further information.

Volumetric dispensing calibration

The purpose of this function is to calibrate the volumetric dispensing function. Calibration shall be performed after each replacement of the cartridges or the POD-Paks. Regular calibration will ensure accuracy of your dispensing.

Note: You will need a 1.0 L graduated cylinder.

Select **Care/Cleaning** app and click on *Volumetric dispensing calibration*. Follow the self-guided wizards.

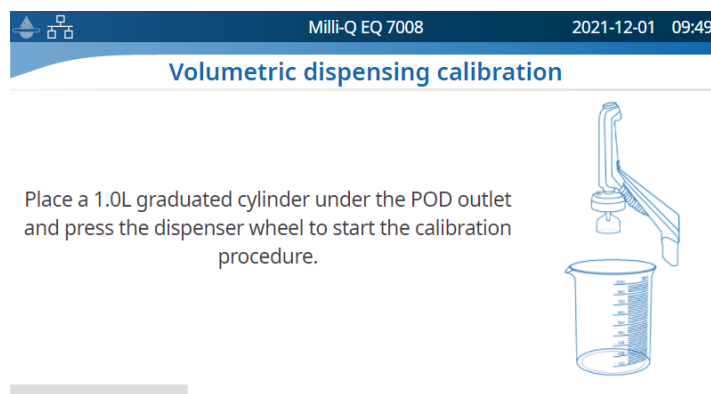

Cleaning the external surfaces

For cleaning and disinfecting the external surfaces of the equipment, use a lint free cloth wet with one of the following disinfecting agents:

- KLERCIDE™ Isopropanol 70% or equivalent composition
- SPOR-KLENZ® (Ready to use) or equivalent composition

Note that applying any other agent on the surfaces could damage them.

UV lamp

Contact the technical support hotline to organize a replacement visit.

It is highly recommended to have a qualified field service representative to change the 185/254 nm UV lamps. Replacement of the lamps involves removing the panels of the Milli-Q® water system.



UV Radiation!

Hazard of illumination will cause eye damage or serious injury.



Hot surface! Hazard of burning.

Important! Never open the system, even when the power switch has been switched off.





It is not sufficient to switch off the system, the plug must be physically removed from its power source. Installation and maintenance should only be done by a qualified person. Appropriate personal protective equipment (PPE) must be worn and safe work practices must be followed.

Depressurization

Two features are available in the **Depressurization** app: the production depressurization and the distribution maintenance. Both features are not necessary during normal operation. Use them in case of water leak to temporarily stop tank filling and all water processes. Identify the source of the leak. Once fixed, don't forget to leave these modes.

Production depressurization

The production depressurization is available by selecting the **Depressurization** app.

Simply press  when the busy-indicator  changes into the ready-indicator  to keep using the system. This temporarily stops production and all water processes. To go back to tank full/tank filling, swipe down from the top of the touchscreen and press .

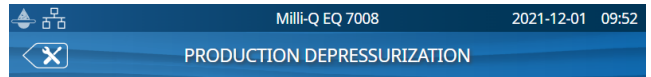

Depressurization of production part in progress

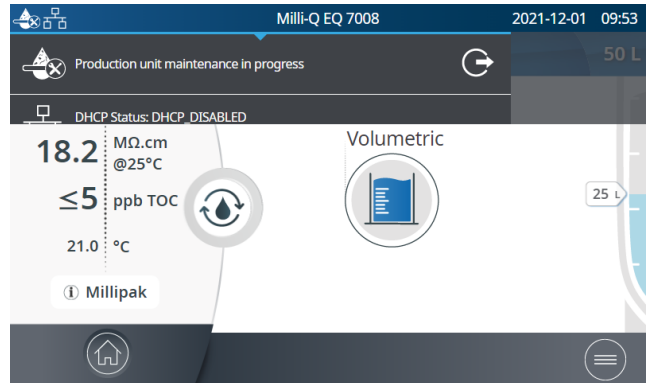

Distribution maintenance

The distribution maintenance is also available by selecting the **Depressurization** app.

Install the Q-POD® unit near a sink and press the dispenser wheel to temporary disable the

dispensing. Press the "Exit maintenance"  button to enable dispensing again.

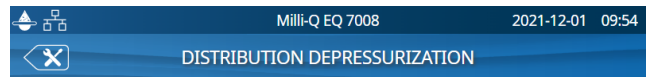

Place the Q-POD near a sink and press the dispenser wheel to depressurize the system.



SELF HELP GUIDE

Troubleshooting tips

Depressurize system

Depressurize system in case of water leak to temporarily stop production and all water processes. Go to page 31 [Maintenance > Depressurization](#).

Identify the source of the leak. Once fixed, to exit this mode, a user will need to go back to the home screen on which the initial depressurization took place and select *Exit maintenance* for dispensing to become available again on the Q-POD® unit.

Turn system off

Press the ON/OFF switch located on the left side of the unit.

Note: When the system is on, the power switch is lit.

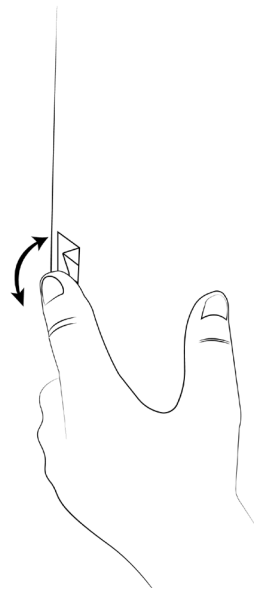

& **UNPLUG**

Important! Never open the system, even when the power switch has been switched off. Hazardous voltage is present and can cause death or serious injury.

It is not sufficient to stop all power to system, the plug must be physically removed from its power source. Installation and maintenance should only be done by a qualified person. Appropriate personal protective equipment (PPE) must be worn and safe work practices must be followed.

If the system is not electrically powered for 20 days or longer, then the date is no longer stored on its circuit board. If this happens, the date and time need to be re-entered, see page 24 [Settings>Date Time & Language](#). It takes about 45 minutes to recharge the capacitor.

Inaccurate volumetric dispensing

Volumetric dispensing has been validated to work $\pm 3\%$ precision. Go to page 29 [Maintenance>Cleaning & Sanitization](#) for more information.

High TOC values

TOC levels can vary depending on the type of feed water or the laboratory environment. Here are a few recommendations to follow:

IPAK cartridges replacement can temporarily increase the TOC until they have been completely rinsed out.

Water stagnation in the tank over a long period of time may also increase the TOC.



Note: There are specific conditions to meet to be able to reach ≤ 5 ppb of TOC.

Low flowrate

- If there is an air vent on the POD-Pak, ensure the POD-Pak is not air-locked. This can happen in the weeks that follow a replacement of IPAK cartridges. Dispense water and open the POD-Pak air vent to see if there is any trapped air. Close the vent once the air has been released.
- One possible reason for a decrease in Milli-Q® water flowrate is a clogged POD-Pak. The POD-Pak should be replaced when it appears to be clogged.

Tank is not re-filled of pure water

- Open the drop down menu swiping down on the touchscreen to check the status of the pure production section.

- Exit the maintenance  or rinsing mode  in case it is activated

- Solve any alarms that could be stopping the production process .

- At the end, make sure the  icon is present on the top left corner of the screen. A blinking icon indicates the tank is being filled. A solid icon indicates a full tank.



IPAK cartridges installation

IPAK Quanta® and IPAK Meta® polishing cartridges installation – new cartridges not recognized.

Important! During the physical replacement in the system unit, both IPAK Quanta® and IPAK Meta® polishing cartridges must first be removed before installing the new set.

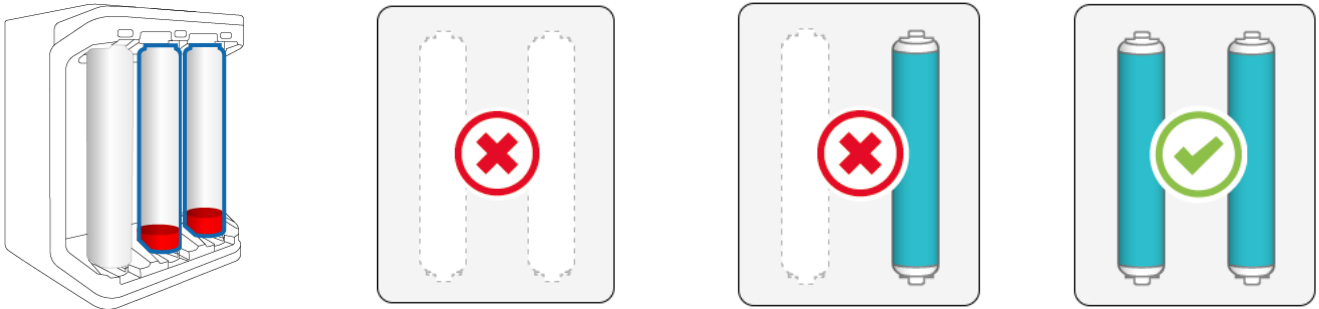

Remove **BOTH** old cartridges.

























Then insert new cartridges.

Check that the e-Sure tag is correctly working. A pre-scan can be initiated by entering into the IPAK Meta & Quanta installation wizard. If the e-Sure tag is working correctly, it will be recognized when scanning the cartridge on the end of the dispenser.

Contact us

Get in contact with the local technical support hotline. The details can be found in the contacts app, go to page 17 [Information >Contacts](#) or visit our website www.sigmaldrich.com

Icons

Icon	Meaning/Function	Icon	Meaning/Function
	Recirculation		Dispensing
	Volumetric dispensing		Back to maintenance, information or settings menu
	Start dispense		Stop dispense
	Alarm with number of active alarm(s)		Alert
	Home		Menu
	Storage tank		System manager logged in
	Mass storage USB connected		Ethernet - LAN status connected
	Slider ON		Slider OFF
	Back		Calendar entry
	Password viewer		Production Unit standby (solid)/ Production Unit producing water (blinking)
	Production Unit blocked		Production Unit maintenance
	Production Unit Maintenance exit		Distribution maintenance exit

REQUIREMENTS AND SPECIFICATIONS

Water specifications

Product Water

With respect to daily, freshly produced water, and when operating within feed water requirements listed in table page 37 [Requirements & Specifications > Water Specifications > Feed Water](#) , the Milli-Q® EQ 7008/7016 water system is intended to dispense pure water that meets or exceeds water quality specifications described by the organizations below.

Parameter	Value or range
Resistivity	18.2 MΩ.cm @ 25°C
Conductivity	0.055 μS/cm @ 25°C
Total Organic Carbon (TOC)	≤ 5 ppb
Particles (size > 0.22μm)	No particles with size > 0.22 μm (with Millipak® filters)
Bacteria	< 0.01 CFU/mL (with Millipak® and Biopak® filters) < 0.005 CFU/mL (with Millipak® Gold installed and used in a laminar flow hood)
Pyrogens (endotoxins)	< 0.001 EU/mL (with Biopak® filter)
RNases	< 1 pg/mL (with Biopak® filter)
DNases	< 5 pg/mL (with Biopak® filter)
Proteases	< 0.15 μg/mL (with Biopak® filter)
Flow rate	< 2 L/min

These values are typical and may vary depending on the nature and concentration of contaminants in the feed water.

Tank Water

Dispensing tank water is possible provided that a tank front valve is installed.

Parameter	Value or range
Resistivity	>0.05 MΩ.cm @ 25°C
RO Ionic rejection	97-98%
Total Organic Carbon (TOC)	< 200 ppb
Colloids	< 1000 ppb
Bacteria	< 1000 CFU/mL (with ASM option installed)

These performances were obtained following our lab conditions testing.

With respect to daily, freshly produced water, the Milli-Q® EQ 7008/7016 system is intended to dispense ultrapure water that meets or exceeds water quality specifications described by the organizations below:

Organization	Water quality / grade
European Pharmacopeia	Purified water in bulk
U.S. Pharmacopeia	Purified water in bulk
Japanese Pharmacopoeia	Purified water
Chinese Pharmacopoeia	Purified water
ASTM® D1193	Type I water
ISO® 3696	Grade 1 water
Chinese National Standard GB/T 6682	Grade 1 water
Chinese National Standard GB/T 33087	Ultrapure water
JIS K 0557	A4 water
Clinical and Laboratory Standards Institute (CLSI®)	Clinical Laboratory Reagent Water (CLRW)

Feed Water

The system has been designed to operate within feed water requirements:

Parameter	Value or range
Pressure	1 bar < P < 6 bar
Type of water	Potable tap water
Temperature	5 - 35°C (41 - 95°F)
Conductivity	< 2000 µS/cm @ 25° C
Dissolved CO ₂	< 30 ppm
Free Chlorine	< 3 ppm
Fouling Index	< 10
pH	4 < pH < 10
Maximum Total Organic Carbon (TOC)	< 2 ppm
LSI	< 0.3
Hardness as CaCO ₃	< 300 ppm
Silica	< 30 ppm
PrePak - maximum total chlorine level	3 ppm for PRPK00001
PrePak - maximum Fouling Index	10 for PRPK000A1

System specifications

Electrical

The power supply converts mains voltage to 28 VDC. The power supply is compatible worldwide.

Catalog	Frequency	Max power	Voltage
ZEQ7008T0C	50/60 Hz \pm 2 Hz	200 VA	100 – 240 V \pm 10%
ZEQ7016T0C	50/60 Hz \pm 2 Hz	200 VA	100 – 240 V \pm 10%

Environmental

Specific environmental conditions have to be respected to ensure normal operation of the Milli-Q® water system.

Location	Indoor use only
Ambient operating temperature	Room temperature ranges from 4°C to 40°C
Relative humidity	Room relative humidity conditions of 80% for a temperature up to 31°C, decreasing linearly to a relative humidity of 50% at 40°C
Altitude	Up to 3000m above sea level
Installation category	Bench / underbench or wall mounted
Pollution degree	2
Means of protection	Class I (PE Connected)
Overvoltage category	II

Communication

Each HMI has a large HD capacitive 7" touch screen (Resolution: 800*480) that allows control and monitoring of the system.

USB

The HMI has a built-in USB port that offers the possibility to export the system data and/or history. The Host interface is compliant with the USB 2.0 High-speed standard.

USB keys only work when formatted FAT32. NTFS format is not compatible.

Ethernet

When connected through an Ethernet protocol, the display interface can be accessed remotely using internet web browsers.

For best browsing performance, Google Chrome™ browser is recommended.

RFID (case with embedded radio feature)

Use only the built-in antenna supplied. Unauthorized modification of the antenna or use of unauthorized accessories might damage the system and render it non-compliant with the EU RED directive and/or FCC regulations.

EU

We certify that these Lab Water Systems are designed and manufactured in application of the following European Council directives:

DIRECTIVE 2014/53/EU OF THE EUROPEAN PARLIAMENT AND OF THE COUNCIL of 16 April 2014 on the harmonisation of the laws of the Member States relating to the making available on the market of radio equipment and repealing Directive 1999/5/EC.

Standards to which conformity is declared as applicable are the following.

Electromagnetic compatibility and Radio spectrum Matters (ERM) tests according to standards: ETSI EN 300 330.

FCC

FCC part 15: 2021 Code of federal regulations.

Title 47 – Telecommunication chapter 1- Federal Communication Commission.

Part 15- Radio frequency devices Sub-part C- Intentional Radiators Limits and Methods of measurement of radio disturbance.

System software

System software included in this product contains copyrighted software that is licensed under the GNU GPL.

The legal notices are available in the HMI display: Information menu > *System* app > Legal Notices.

Power and water consumption

Power consumption

The actual power consumption (VA) in each mode of a Milli-Q® EQ 7016 water system is described below:

Voltage and Frequency	Standby (VA)	Recirculation (VA)	Distribution (VA)	Production (VA)	Production + distribution (VA)
100 V - 50 Hz	27	52	76	60	110
100 V - 60 Hz	27	53	77	59	110
240 V - 50 Hz	48	67	86	77	118
240 V - 60 Hz	52	74	94	79	122

The following data have been collected according the experimental method described below:

- Production time of 7 hours per day, 217 days per year.
- 10 manual recirculation events per day (1 before each dispense) of 30 seconds, 250 days per year
- 10 dispense of 30 seconds a day (each dispense is followed by a 90 seconds post-dispensing recirculation for TOC measurement)
- 24 automatic recirculation events per day, 365 days per year
- The produced water is dispensed from the HMI.

Water consumption

Even though it depends upon the water system type (EQ 7008 or EQ 7016) and feed water quality, an average of 3.1 L of feed water is needed to produce 1 L of type 1 purified water.

Dimensions and weights

Water purification system (7008/7016 wall mounted): dimensions in mm.

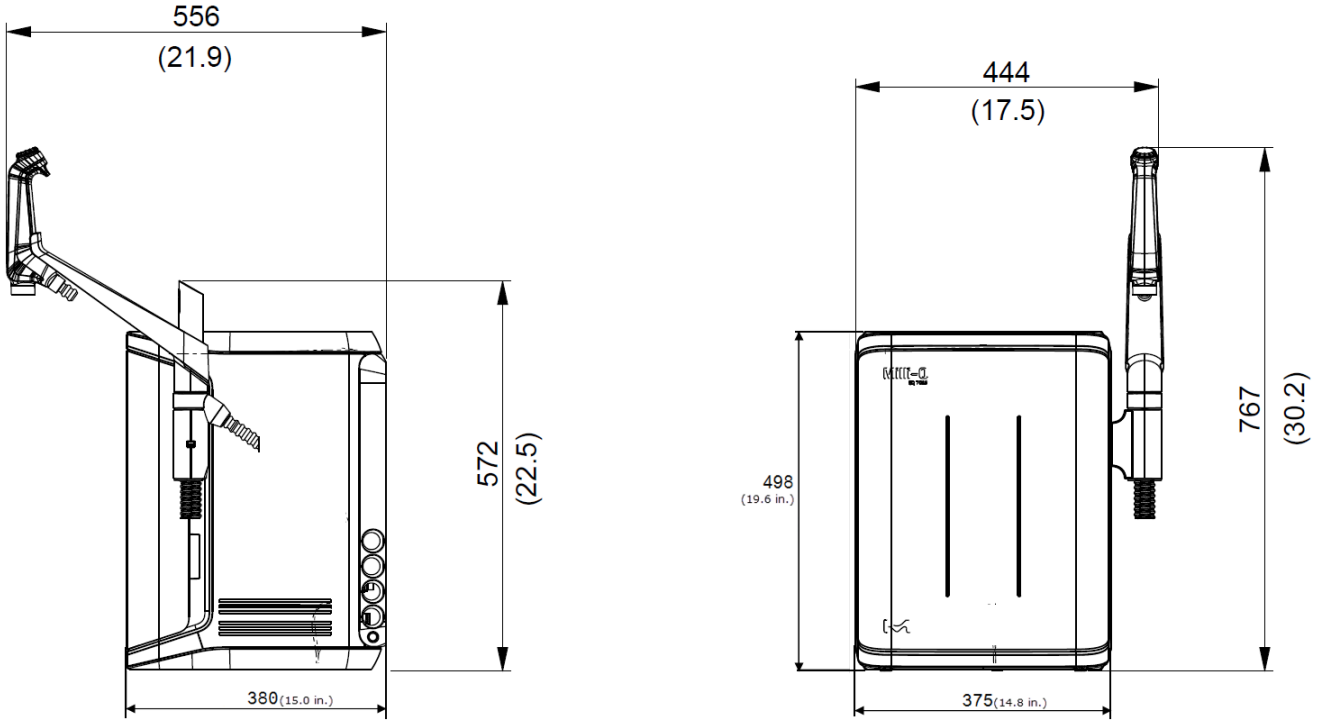

HMI display: dimensions in cm.

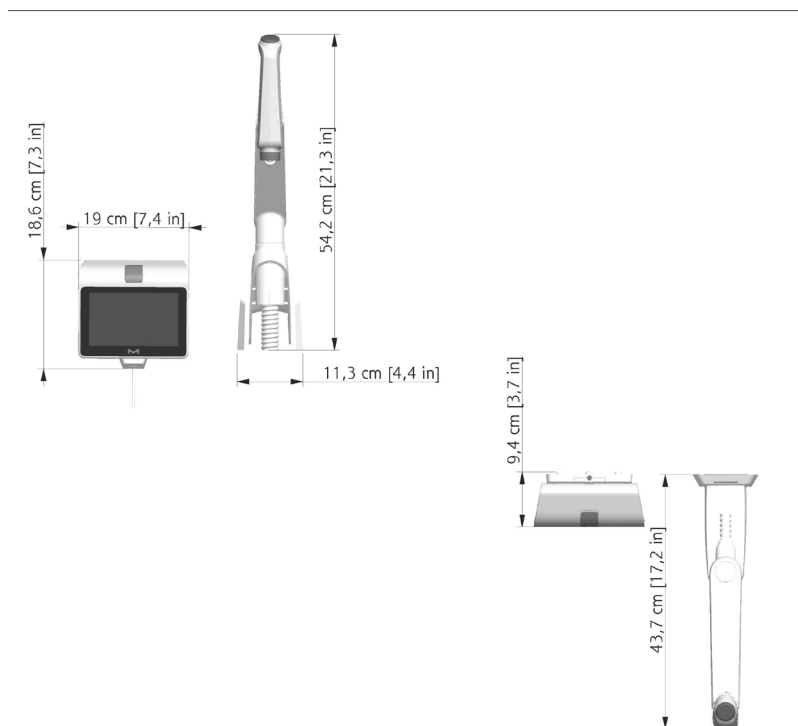

Storage tank 25 L - 50 L - 100 L: dimensions in mm.

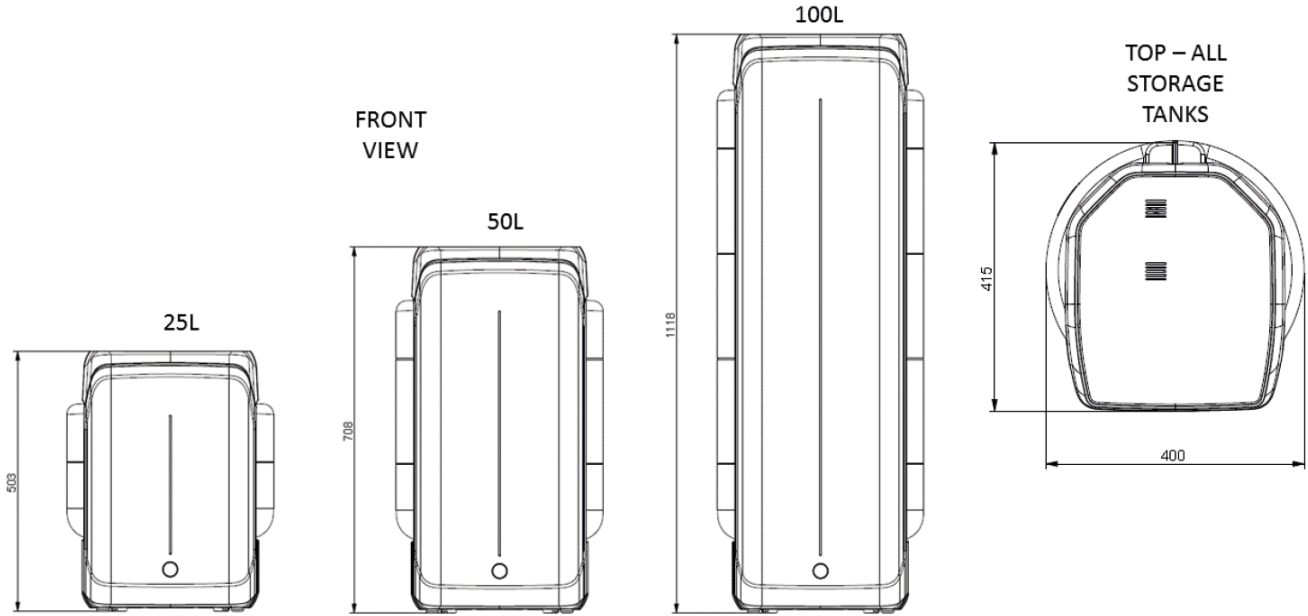

System type	Dry weight	Shipping weight	Operating weight
Milli-Q® EQ 7008 water system	19.0 kg (41.9 lb)	22.4 kg (49.4 lb)	25.2 kg (55.6 lb)
Milli-Q® EQ 7016 water system	19.7 kg (43.4 lb)	23.1 kg (50.9 lb)	26.5 kg (58.4 lb)
Q-POD® dispenser (system-mounted)	1.2 kg (2.7 lb)	1.5 kg (3.3 lb)	1.2 kg (2.7 lb)
Wall mounted kit for Q-POD	2.2 kg (4.9 lb)	2.8 kg (6.1 lb)	2.2 kg (4.9 lb)
HMI (only)	0.58 kg (1.3 lb)	/	0.58 kg (1.3 lb)
Bench Top Kit For HMI	0.42 kg (0.9 lb)	0.56 kg (1.2 lb)	0.42 kg (0.9 lb)
Water storage 25 L	6.7 kg (14.8 lb)	8.5 kg (18.7 lb)	31.7 kg (69.9 lb)
Water storage 50 L	7.6 kg (16.8 lb)	10.6 kg (23.4 lb)	57.6 kg (127 lb)
Water storage 100L	10.9 kg (24.0 lb)	12.8 kg (28.2 lb)	110.9 kg (244.5 lb)

Dry Weight is defined as a system without its shipping container. Consumables and accessories are not included.

Shipping Weight is defined as a dry system in its shipping container. Consumables and accessories are not included.

Operating weight is defined as a wetted system with all its consumables, but not any accessories.

Note: For wall mounting installation, use a concrete wall capable of supporting a max load of 120 kg. Use 6 mm diameter stud and fasteners capable to support a minimum load of 60 kg each.



Recycling

Directive 2012/19/UE:

For European users only

The symbol “crossed bin” on a product or its packaging indicates that the product should not be treated like household waste when discarded. Instead the product should be disposed of at a location that handles discarded electric or electronic equipment.

Proper disposal of equipment containing electric or electronic components will help to reduce pollution effects to the environment or to human health. Proper recycling of these products helps in environmental preservation and helps to protect natural resources. For more information about recycling of products containing electric or electronic components, please contact your local recycling representative or organization.

Ordering information

System components

Description	Catalog Number
Wall mounting Kit for Q-POD (includes Q-POD® unit)	WMEQ0RKT
System mounting kit for Q-POD (includes Q-POD® unit)	SMEQ00KT
Wall Mounting Kit For HMI	WMEQ0DKT
Bench Top Kit For HMI	BTEQ0DKT
System Wall Mounting Bracket	SYSTFIXA1
Wall mounting bracket for storage tank	TANKFIXA1
Storage tank frame 25 L	TANKA025
Storage tank frame 50 L	TANKA050
Storage tank frame 100 L	TANKA100
Storage tank top assembly (does not include ASM)	TANKT0PEQ
Storage tank top assembly (includes ASM)	TANKT0PA1
Connector 2 m System-Tank	ZFC0NN2ST
Connector 5 m System-Tank	ZFC0NN5ST

Accessories

Description	Catalog Number
Water sensor	ZWATSENA1
Foot pedal	ZMQSFTSA1
Alarm relay cable	ZMQ0ALCA1
Washer Distribution kit 230 V Left	ZWDK5L100
Washer Distribution kit 230 V Right	ZWDK5R100
Washer Distribution kit 115 V Left	ZWDK6L100
Washer Distribution kit 115 V Right	ZWDK6R100

Description	Catalog Number
Washer Distribution kit Adaptor	ZWDKADPA1
Washer dist kit wall mounting bracket	WMBWASHA1
Tank valve kit	ZFTVK07A1
External solenoid valve	EXTSV00A1
Multi system installation kit	ZIQ7MSKT1

Consumables – order at www.mymilliqconsumables.com

Description	Catalog Number
IPAK Gard®, IPAK Meta®, & IPAK Quanta® and vent filter consumable kit	EQ70XXPKT1
IPAK Gard®, IPAK Meta®, & IPAK Quanta® and vent filter consumable kit with polyphosphate	EQ70XXPKT1H
IPAK Meta® & IPAK Quanta® polishing cartridges consumable kit	IPAKKITA1
IPAK Gard® pretreatment pack	IPAKGARA1
IPAK Gard® pretreatment pack with polyphosphate	IPAKGAR1H
UV Lamp	ZEQ7UVLP0
Millipak® 0.22 µm filter	MPGP002A1
Millipak® Gold 0.22 µm sterile filter	MPGPG02A1
Biopak® polisher	CDUFBI0A1
LC-Pak® polisher	LCPAK00A1
EDS-Pak® polisher	EDSPAK0A1
VOC-Pak® polisher	V0CPAK0A1
ROCare A	ZWACID012
ROCare B	ZWBASE012
ROProtect C	ZWCL01F50
EfferSan Effervescent Tablets (US)	5874316024
EfferSan Effervescent Tablets (CA)	5874316024C
Ech ₂ o® ASM Lamp	ASMUVLPA1
Vent filter HF (for high flow applications)	TANKVH1A1
Vent filter	TANKV01A1
PrePak filter pretreatment pack ([Cl ₂] < 1 ppm and FI < 10)	PRPK000A1
PrePak filter pretreatment pack ([Cl ₂] < 3 ppm and FI < 5)	PRPK00001
Pack Support 2 Tubes 2 Gauges	ZFPAKSP2

LEGAL INFORMATION & WARRANTY

It has always been Millipore SAS policy to continuously improve its products.

The information in this document is subject to change without notice and should not be construed as a commitment by Millipore SAS. Millipore SAS assumes no responsibility for any errors that might appear in this document. This user manual is believed to be complete and accurate at the time of publication. In no event shall Millipore SAS be liable for incidental or consequential damages in connection with or arising from the use of this user manual.

Product warranty and limitation of liability

The applicable warranty and limitation of liability for the products listed in this publication may be found at www.sigmaaldrich.com within the "Conditions of Sale" applicable to your purchase transaction.

Copyright

© Millipore SAS 2022.

All rights reserved. This document or parts thereof may not be reproduced in any form without the written permission of Millipore SAS.

The photographs illustrating the products are non-contractual.

Trademarks

New trademark names

The initial M, Millipore, Milli-Q, Q-POD, ech2o, IPAK Gard, IPAK Meta, IPAK Quanta, Jetpore, IQnano, Millipak, Biopak, LC-Pak, EDS-Pak, and VOC-Pak are trademarks of Merck KGaA, Darmstadt, Germany. Millipore SAS is an affiliate of Merck KGaA, Darmstadt, Germany.

The Life Science Business of Merck KGaA, Darmstadt, Germany operates as MilliporeSigma in the US and Canada.

Safety information

Your Milli-Q® system should be operated according to the instructions in this user manual. In particular, the hydraulic and electrical specifications should be followed and met. It is important to use this equipment as specified in this manual; using this equipment in a different manner may impair the safety precautions of the Milli-Q® system.

Never open the system, even when the power switch has been switched off. Hazardous voltage is present. It is not sufficient to stop all power to system, the plug must be physically removed from its power source. Installation and maintenance should only be done by a qualified person. Appropriate personal protective equipment (PPE) must be worn and safe work practices must be followed.







Document Reference: vm-um-milli-q-eq-70xx-en

Revision: V2.0

Safety information

Never open the system, even when the power switch has been switched off.

100-240 VAC ELECTRICITY AND UV LIGHT INSIDE!

Symbol	What it means
	This UV RADIATION sticker is used to refer to a position on the water system cabinet or inside of it where exposure to UV light is possible.
	This DANGER sticker is used to refer to a position on the water system cabinet or inside of it that could be hazardous.
	This CAUTION sticker is used to refer to a surface that can be hot. Disconnect and switch power off to allow surface to cool before servicing.
	This ELECTRICAL GROUND sticker is used to refer to a position on the water system cabinet or inside where an electrical ground connection is made.
 Hazard	The Milli-Q® system must be connected to a source of electrical power that is earth grounded.
 Attention	Before the system is serviced, unplug the electrical power cord. The Milli-Q® system must be powered OFF before plugging in or removing any components on the electronic board(s).

The Milli-Q® EQ 7008/7016 water system has been tested by an independent and accredited company for compliance with EU directives related to safety and electromagnetic compatibility. The declaration of conformity is available upon request. The system has been manufactured using components and practices recommended by UL and has been cULus marked. The registration and CB certificates can be verified at www.members.IECCE.org.

In case of wall mounted installation:

For the Milli-Q® EQ 7008/7016 water system: Use a wall capable of supporting a minimum load of 120 kg. Use 6 mm diameter stud and fasteners capable to support a minimum load of 60 kg each.

For the 25 L tank: Use a wall capable of supporting a minimum load of 130 kg. Use 6 mm diameter stud and fasteners capable to support a minimum load of 45 kg each.

For the 50 L tank: Use a wall capable of supporting a minimum load of 240 kg. Use 6 mm diameter stud and fasteners capable to support a minimum load of 80 kg each.

For the 100 L tank: Use a wall capable of supporting a minimum load of 500 kg. Use 6 mm diameter stud and fasteners capable to support a minimum load of 180 kg each.

The vibrant M, Milli-Q, and Sigma-Aldrich are trademarks of Merck KGaA, Darmstadt, Germany or its affiliates. All other trademarks are the property of their respective owners. Detailed information on trademarks is available via publicly accessible resources.
© 2021 Merck KGaA, Darmstadt, Germany and/or its affiliates. All Rights Reserved.

The life science business of Merck KGaA, Darmstadt, Germany operates as MilliporeSigma in the U.S. and Canada.

